

**DENVER POLICE DEPARTMENT
CRIME PREVENTION
INFORMATION PACKET**

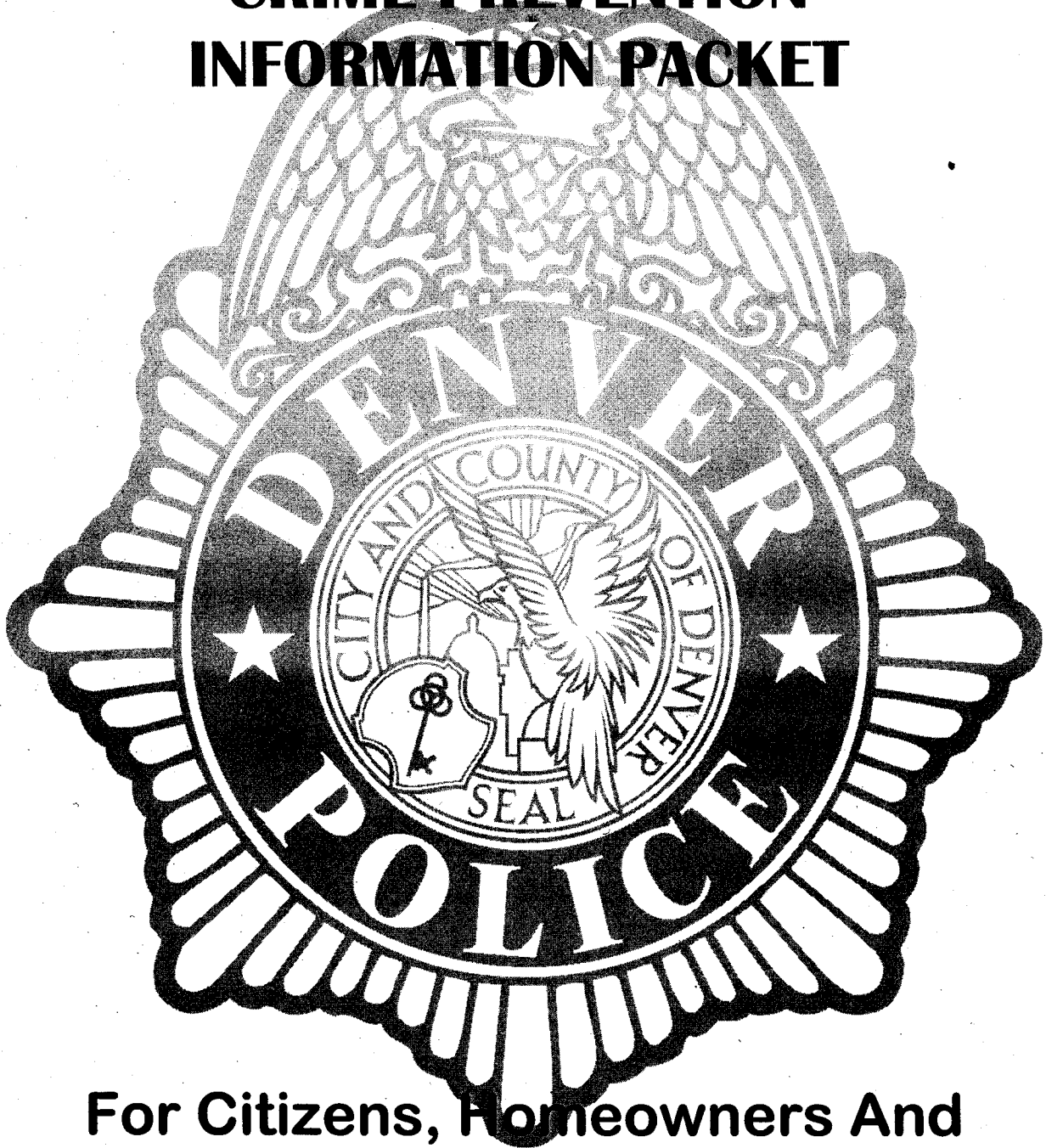

**For Citizens, Homeowners And
Businesses**

A GUIDE TO YOUR INFORMATION PACKET

In this packet, you'll find a wealth of information: tips on protecting yourself, your family, your property, and your business. You'll learn about various free services offered by the Denver Police Department such as Neighborhood Watch, Home Security Checks, Parent Watch and Stranger Awareness.

The safety and welfare of the citizens of Denver is of paramount concern to the Denver Police Department. We believe that police and community working together can make a difference and we welcome your involvement. Crime prevention can only be realized with the involvement of informed citizens. It is the aim of this Information Packet to better inform you of the steps you can take to protect yourself against crime.

The following information is brought to you as a free service by the Denver Police Department.

Don't become a victim. Become involved.

District One
720-913-0400

District Two
303-331-4070
720-913-1000

District Three
303-698-3333
720-913-1300

District Four
303-937-4444

District Five
303-376-2300

District Six
~~303-839-2100~~
720-913-2800

Thank you and stay safe!



DENVER POLICE DEPARTMENT NEIGHBORHOOD WATCH INFORMATION SHEET

Neighborhood Watch is a program aimed at preventing crime and making our homes and families safer. Neighborhood Watch is a partnership between the police department and the community.

Inventory Record is simply the marking of your valuables with the number provided to you by the Denver Police Department, prefixed by "CO" for Colorado, for example, CO123456. We suggest you mark your high-risk items such as VCR's, TV's and cameras by using a scratch awl, ice pick or other sharp tool. You should photograph smaller items such as jewelry and silverware. If your marked items are stolen and recovered, these identification marks increase your chance of getting them back. Each household which returns the Neighborhood Watch sign-up card will receive decals for their doors and windows. You keep the inventory sheet for your files in a safe place (such as a safe deposit box) for future reference.

Neighborhood Watch means neighbors watching out for each other by reporting suspicious parties, vehicles and activities to the Police Department. If your block participates in Neighborhood Watch, the City will provide Neighborhood Watch signs for your block. These signs forewarn criminals that the neighborhood is organized against crime and the residents are looking out for each other!

There are two steps to follow in setting up a program:

1. Determine the interest in your neighborhood by going door to door. You must have a significant portion of the block to participate. Also, decide on an appropriate date and time which is convenient for everyone to hold a meeting to talk about the Neighborhood Watch Program. Please try to have at least two or three dates.
2. Contact your Community Resource Officer with the dates and times. The Community Resource Officer will work with you to schedule the best possible time for the meeting.

If you have any questions regarding Neighborhood Watch, or any CRIME topic, please contact your local Denver Police District Station. Please refer to the map at the back of this book to determine which District Station is responsible for protecting your neighborhood.



HOW TO PROTECT YOURSELF

1. Protect your neighbors as well as yourself. Never mention to a stranger that a neighbor lives alone or is at home alone.
2. If a stranger requests to use your phone, do not permit the stranger to enter. Offer to summon emergency assistance or to make the call for him or her.
3. If you should receive a wrong-number call, never reveal your name, address, or admit you are alone. Do not give your phone number to an unknown caller, but ask what number they are trying to call. Do not prolong the conversation. Hang up. Notify the police of any obscene phone calls.
4. Keep windows secured and install window locks on those left open for ventilation. Limit openings to spaces small enough to prevent entry.
5. Be cautious about entering an apartment house elevator with strange people. It is wiser to remain in the lobby for a few minutes.
6. When using a laundry room in an apartment house, never remain there alone. Get a friend or neighbor to accompany you.
7. Leave your front and back porch lights on at night. This is inexpensive and very effective.
8. Do not allow any solicitor, repair person, etc. in your house unless you have requested them. If the person seems suspicious verify their ID and call the company they work for.
9. Never give personal information over the phone if the call was not initiated by you.



Should I Carry a Weapon?

- Guns, tear gas pens, knives, etc., can easily be turned against you - unless you are thoroughly trained in their use.
- Also, it is illegal to carry some kinds of weapons.
- It is probably best not to carry a weapon.

If You Are Attacked and Decide to Resist:

1. Attempt to run away.
2. Scream as loud as you can to attract attention.
3. Strike back fast, aim for vital spots.
4. Gouge eyes with thumbs; scratch with fingernails.
5. Jab knee into groin area.
6. If you are attacked from the rear, dig heels into instep, kick at shins. Strike attacker's face with the back of your head.
7. Carry a whistle, use it to attract attention if attacked.

SELF PROTECTION FOR WOMEN

All too often women become victims of crimes that they might have prevented by taking simple precautions. If you are home alone, or travel unescorted, you should be aware of measures you can use to safeguard yourself.

When Walking...

When walking alone at night, walk briskly and with confidence. Look around to see whether you are being followed. Notice people who pass you. Avoid shortcuts. If someone suspicious is following you, look for an open business or go to a nearby home for assistance. If nothing else is available, head for a well-lighted area where there are other people.

Don't accept rides from strangers. If a car approaches you and you are threatened, scream and run in a direction opposite that of the car. If someone attempts to force you into a car, be prepared to defend yourself. Do not get into the car unless it is absolutely unavoidable.

Your purse is a likely target for an attacker. Never carry large amounts of money in your purse. If an attacker grabs your purse, let it go. It is better to lose your purse than to risk injury defending it.

Have your key ready so your house door can be opened immediately.



Do not pick up hitchhikers. Avoid stopping at lonely, out-of-the-way, or poorly lighted places even for car service. If you have car trouble, raise the hood and activate your emergency lights. Stay in the car with the windows closed and the car locked until you are sure of the intent of any person offering assistance. If a person attempts to gain entry, or is otherwise a threat, sound your horn until the person leaves, or until help is attracted.

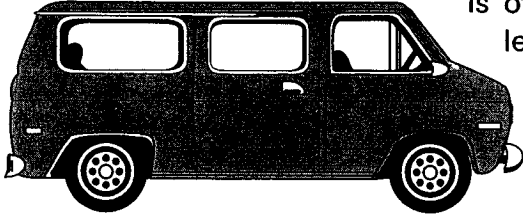

Avoid stopping to aid disabled motorists. Wait until you can report it to the police or a service station.

Park only in a well-lighted spot near enough to your destination for safety. Look around for loiterers before leaving the car.

Lock your car whenever leaving it. Place any packages or other valuables in the trunk, out of sight. This will help safeguard property inside and discourage thieves. Upon your return, look behind the front seat before you enter the car. A criminal may have entered to await your return.

Upon arriving at home, keep the headlights on until the garage is opened, the car is parked, and the house door is unlocked. Be particularly alert when going into apartment house garages. If possible, have a friend or neighbor meet you. Keep your keys in your hand in case someone tries to attack you.

Do not leave your children in your car unattended. Never leave your car running unattended.

If your car is taken by force do not fight. Get out, get your children out and get away for the vehicle. Call police immediately.

On rare occasions there have been people who have impersonated police officers and stopped people in their vehicles. It is the policy of the Denver Police Department that police vehicles conducting traffic stops will be equipped with emergency lights and siren.

If you are stopped by a vehicle that you are unsure is a real police car and are suspicious of the person who contacts you, the Denver Police Department recommends you do the following:

- Lock your car doors and partially roll down your window
- Keep in mind some officers do not wear a uniform, ask for police identification other than a badge
- Ask what City Police Department, police district he or she works at
- If still suspicious, call the Denver Police Department emergency line (911), and ask them to verify an officer has made a traffic stop at your location.

Prevent Auto Theft and Theft From Your Vehicle. . .

- Never leave your keys in the car or ignition.
- Always lock your car, even if it is in front of your home.
- Copy your tag number and vehicle identification number (VIN) on a card and keep them with your driver's license. Keep the second copy of the registration with you.
- Keep the key to your home and car separate.
- Keep your car in good running condition, Make sure there is enough gas to get there and back.
- Avoid parking in isolated areas with little foot or auto traffic. Be especially alert in un-staffed lots and enclosed parking garages.
- If you think someone is following you, drive to the nearest police or fire station, open service station, or other open business to get help.
- Do not pick up hitchhikers.
- If you often drive at night, or alone, consider a cellular phone to make it easier to summon help in an emergency.
- Do not warm up your car in the morning without you being in it.
- Do not leave your car started or with the keys in it while you go into a store.
- Always put valuables in the trunk of the car. (especially while shopping)

CHILD SAFETY

1. The old rule about never taking candy from a stranger is still a very good rule.
BUT PLEASE TELL YOUR CHILDREN WHY!
2. Tell your children never to talk to a stranger.
BUT TELL THEM WHY!
3. Tell your children to never tell anyone they are home alone when answering the phone.
BUT TELL THEM WHY!
4. Select one or two neighbors who will give your children sanctuary should any threat or emergency arise while you are not present. Offer to do the same for them.
5. Instruct your children to look out for each other. Be sure they tell you whenever something strange or suspicious occurs.
TELL THEM WHY!
6. Report any suspicious persons or vehicles lurking in areas where children play. Obtain a description and license number if possible.
7. Teach your children where to look for license plates on vehicles.
8. Be prepared to assist any child who appears to be lost or in trouble.
9. Please teach your child the emergency assistance number: **"9-1-1"**.

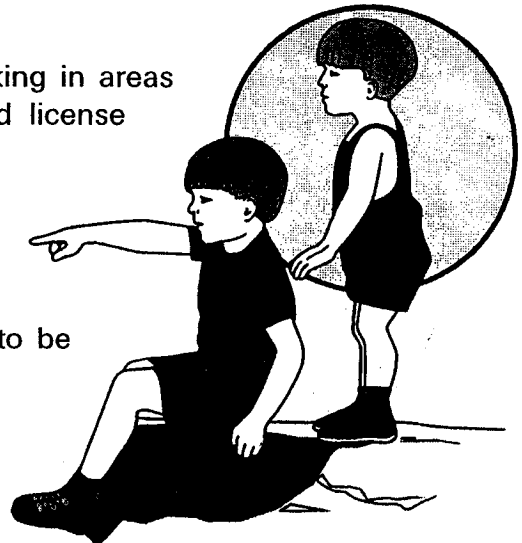

CHILD SAFETY

1. The old rule about never taking candy or money from a stranger is still a very good rule.
BUT PLEASE TELL YOUR CHILDREN WHY!
2. Tell your children never to talk to a stranger.
BUT TELL THEM WHY!
3. Tell your children to never tell anyone they are home alone when answering the phone.
BUT TELL THEM WHY!
4. Select one or two neighbors who will give your children sanctuary should any threat or emergency arise while you are not present. Offer to do the same for them.
5. Instruct your children to look out for each other. Be sure they tell you whenever something strange or suspicious occurs.
TELL THEM WHY!
6. Report any suspicious persons or vehicles lurking in areas where children play. Obtain a description and license number if possible.
7. Teach your children where to look for license plates on vehicles.
8. Be prepared to assist any child who appears to be lost or in trouble.
9. Please teach your child the emergency assistance number: **"9-1-1"**.
10. Contact you local Denver Police District Station for information regarding Parent Watch and Stranger Awareness programs.

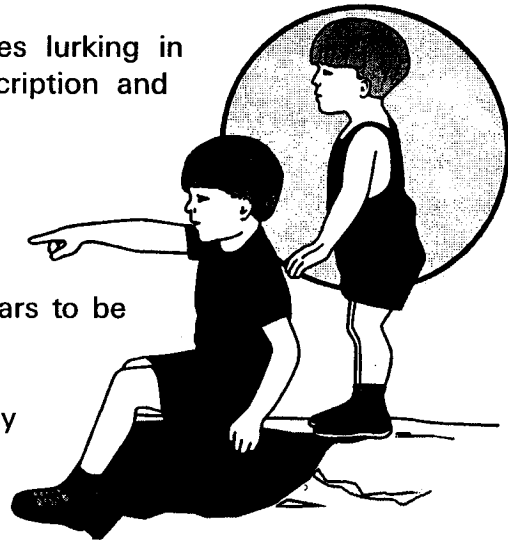

CHILD MOLESTERS AND HOW TO AVOID THEM

Every community has problems with child molesters. Unfortunately, it is very hard for the police department to catch this type of person due to the age of the victims. Victims are usually young children from elementary schools who have not been properly instructed by their parents on what to watch for and how to avoid the child molester.

Children are naturally friendly, but being friendly toward strangers can be dangerous.

The following information should be read by every parent and discussed with every child if we are to rid our community of the child molester and avert tragedy involving our children.

- ✎ Never take a ride in a car with a person you do not know. Beware of strangers. You can be hurt by a stranger. If a stranger asks you to go for a ride, get away FAST!
- ✎ Write down the license number of the car of anyone who tried to pick you up. If you don't have a pencil, scratch the number in the dirt with a stick. Report it to a policeman or your parents right away. This number will help the police to catch the person who tried to get you. Remember, the police do not want anyone to hurt you.
- ✎ Never take money or candy or other gifts from any stranger. Do not let any stranger touch you. If someone tries, get away fast and report it at once to the police, an adult or your parents.
- ✎ Do not play in empty buildings or alleys. Do not go to places alone where you might not be seen by someone else. If something should happen to you, there would be no one to help you. Play with a friend, not alone.
- ✎ Do not go to the movies alone. Go with a friend or adult. If anyone tries to touch you in the movies, call an usher or the manager right away.
- ✎ Do not go to the restroom with anyone you do not know. Never enter any building with a stranger, even if he or she appears friendly.
- ✎ Remember that police officers are your friends. They like children and do not want you to get hurt. If something happens, tell a police officer and/or your parents. They will understand.
- ✎ Always let your parents know where you are going and who you are with.

BASIC BICYCLE PROTECTION

1. You may voluntarily register your bicycle with the Denver Police Department.
2. Keep a written record of your bike's registration number, serial number, make and color.
3. To avoid bike theft:



Do not leave your bike in the front or backyard.



Do not leave it unlocked in the garage.



Do not leave it unlocked on the school yard or parking lot.



4. Always lock your bike with a good bike lock or case hardened lock and chain.
5. Avoid personal injury. Remember to practice good bike safety. All traffic laws apply to bicycles, too.
6. Encourage school and recreation authorities to provide secure racks where bicycles can be observed by employees of the facility.
7. Always wear a helmet when riding. It could save you or your loved one's life if an accident occurs.
8. While riding at night wear reflective clothing and use front and rear lights.
9. If someone tries to steal your bike while you are on it, do not resist. It is not worth being injured. Call police immediately.

REMEMBER: IF YOU ARE A VICTIM, CALL THE POLICE AT 720-913-2000.



How to Secure Your Bicycle

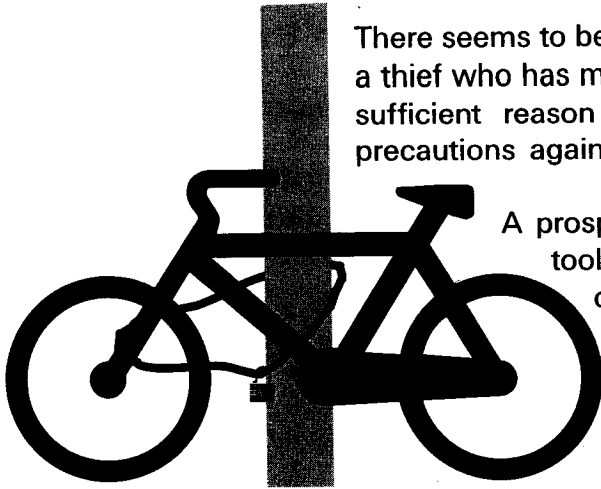





There seems to be no foolproof way to keep your bicycle safe from a thief who has made up his or her mind to have it, but that is not sufficient reason to either give up biking or to stop taking precautions against thievery.

A prospective bike thief needs time, concealment and tools to be successful. There are ways in which you can reduce the thief's opportunities and make your bicycle more trouble to steal than it's worth.

The basic security of a bike lock seems a good place to start in discussing preventative measures. One should understand that a professional thief can remove any chain or bike lock, no matter how tough and sturdy, if he/she has the proper tools and sufficient time.

Heat-treated, (case-hardened) alloy steel chains 3/8" diameter, offer good security. Also of heat-treated alloy, slightly smaller chains, 3/16" or 1/4", offer good protection, being completely resistant to wire cutters and bolt cutters up to 18 inches in length. Wire cables usually afford protection against the casual or amateur thief since non-tempered chains can be easily snapped by bolt cutters or even wire cutters. Consult a local bike retailer for recommendations on bike locks.

When considering the quality of a padlock, keep in mind these factors:

-  Will the shackle resist attacks by bolt cutters, files, and hacksaws?
-  Will the locking device prevent the shackle from being spread, pried or twisted off the body?
-  Will the body resist attacks from bolt cutters, cold chisels and hacksaws?
-  Can the keyway be picked, removed by force, or drilled out?
-  Will the padlock material stand up against weather and other external elements?

Perhaps the most important factor in bike security is the act of locking the front **AND** rear wheels **AND** the frame to a permanent pole or other object. Make sure that the object to which you're locking your bike is stable enough that it can't be cut, sawed or picked up and carried away, with your bike still locked to it.

PERSONAL SAFETY WHILE DRIVING

1. Keep your vehicle doors locked while driving, even while on short trips such as to and from the store or on errands.
2. Keep your doors locked even while parked and waiting. This will help keep the intruder out, and secure your safety.
3. Approach your vehicle from the passenger side door. Look in the front and back seat of your vehicle. Also check under the vehicle as you approach it.
4. **DO NOT PICK UP HITCHHIKERS...**
Every day people are victims of all types of crimes perpetrated by hitchhikers.
5. In the event that you see a person or vehicle in need of assistance on the highway or street, **DO NOT STOP**. Instead, look for a police officer or call the local police or highway patrol and ask that assistance be sent.
6. As an additional safeguard, consider a locking gas cap and/or an auto alarm.
7. Park in well lighted areas, avoid parking on dark and secluded streets and parking lots whenever possible. If possible, have someone go with you to your vehicle at night.

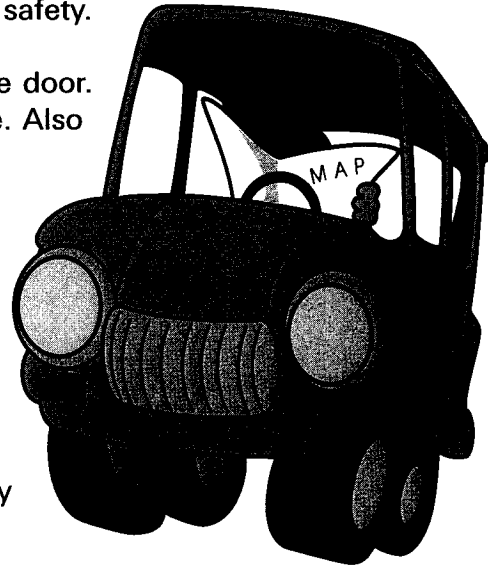

PLEASE REMEMBER!

BE AWARE THAT THERE IS A GREAT DEAL MORE TO AUTO SAFETY THAN JUST WATCHING THE OTHER GUY OR DRIVER: WATCH YOURSELF.



HOW TO GIVE A DESCRIPTION

Person

1. Sex
2. Race
3. Complexion
4. Age: if unknown, estimate
5. Height: Estimate in two inch blocks. For example, between 5'8" and 5'10"
6. Weight: Estimate in blocks of ten pounds. For example, 130 to 140 pounds
7. Build: Large, medium, small, stocky, fat, slender or thin, and any distinguishing features on parts of body (tattoos, eyeglasses, etc.)
8. Hair: Color, length, thick or thin, balding or full, sideburns
9. Mustache or beard: Describe, including color
10. Clothing: Type, color, style. Start at the top and work down: hat, coat, shirt, pants, shoes
11. Method of escape: Vehicle or on foot, direction of travel

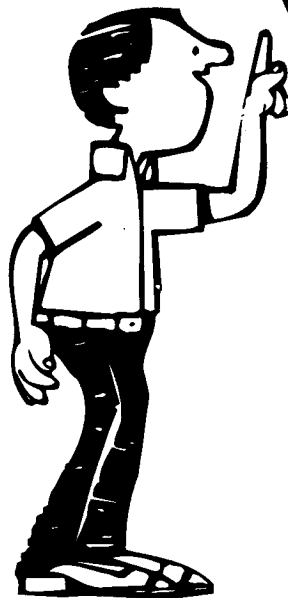

Male, White, ruddy complexion, approximately 45 years old. Between 5' 6" and 5' 8", 150 to 160 pounds, medium build, grey hair, thinning on top, long sideburns, brown handle-bar mustache. Wearing a blue baseball cap, no coat, white shirt, dark pants and sneakers.



SUSPECT IDENTIFICATION SHEET - KEEP THIS NEAR YOUR PHONE

REPORT ALL INSTANCES OF CRIME IMMEDIATELY

EMERGENCY - CALL 9 - 1 - 1

For Non-emergency Assistance, Call 720-913-2000

Talk Slowly And Clearly. You Will Be Asked Several Questions

Answer Each One Carefully

STAY ON THE TELEPHONE ... DO NOT HANG UP



FILL IN AS MUCH INFORMATION AS YOU CAN. GIVE THIS SHEET TO THE FIRST OFFICER WHO ARRIVES.

Location _____

Type of Crime _____ Date _____

Your Name _____ Time _____

Phone (Home) _____ Phone (Work) _____

SUSPECTS

How many suspects? _____ Have you seen the person(s) before? _____

When? _____ Where? _____

DESCRIPTION(S)

#1 Race _____ Sex _____ Age _____ #2 Race _____ Sex _____ Age _____

Height _____ Weight _____ Height _____ Weight _____

Hair _____ Eyes _____ Hair _____ Eyes _____

Facial Hair _____ Facial Hair _____

Hat _____ Hat _____

Coat/jacket _____ Coat/jacket _____

Shirt _____ Shirt _____

Pants _____ Shoes _____ Pants _____ Shoes _____

Scars/marks/unusual actions _____ Scars/marks/unusual actions _____

_____ Accent? _____

Quote suspect's demands: _____

ESCAPE

Direction _____ How? On foot Vehicle

VEHICLE USED

Car Truck Van Motorcycle

Make _____ Model _____ Year _____

Color _____ License No. _____ State _____

Anything unusual? _____

WEAPON

Was a weapon shown? _____ What? _____

Describe the weapon _____

Color Dark blue/black Silver

REVOLVER

AUTOMATIC

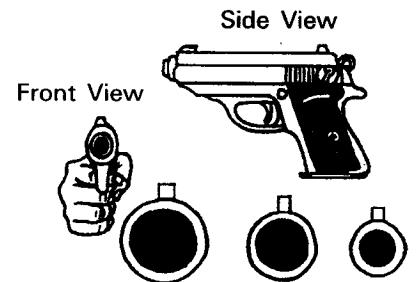
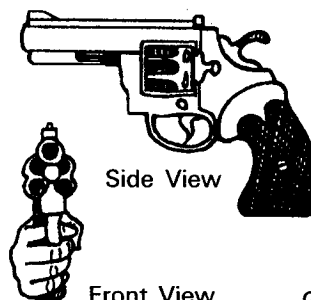

GUN CALIBER/
BARREL WIDTH Large Medium Small

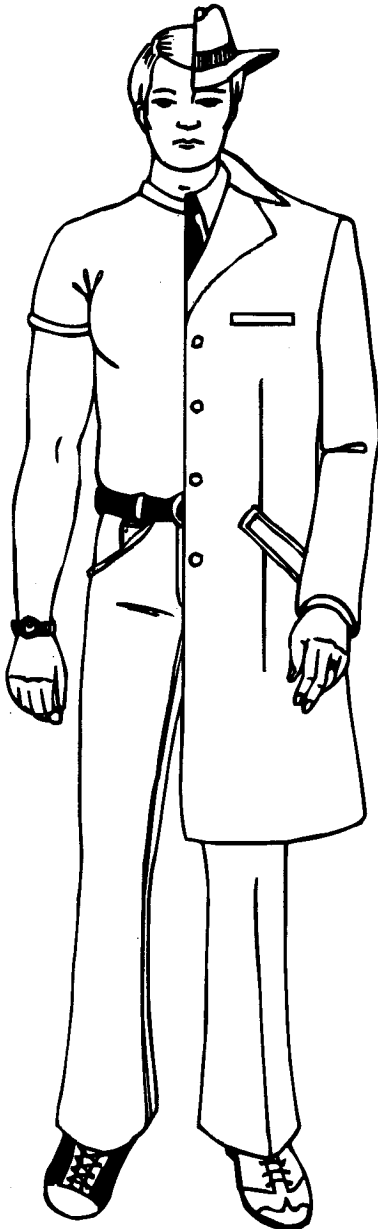

Signature of Person Completing Form _____

Date _____ Time _____

Vehicles

1. Color
2. Make and year (if year is unknown, estimate), late model or old
3. Body type: sedan, two door, convertible, station wagon, pickup, van
4. License plate number and specify state
5. Exterior attachments or damage.

EXAMPLE: A black, late model Plymouth, four door sedan, Colorado license plate number YD 312, with spot light on driver's side and large dent on rear passenger side.

Escaping Vehicles

1. Color
2. Make and year (as above)
3. Direction of travel: what street is it on, what cross street is approaching, give directions (northbound, westbound) if known
4. Body type (as above)
5. License plate number and specify state
6. Exterior attachments or damage
7. Number of occupants and description

EXAMPLE: A black, late model Plymouth, traveling north on Lincoln Avenue approaching East 13th Avenue. One male, white, fair, 18-21 years old, 5'10", 160 - 170 pounds, wearing jeans, sport shirt, no hat.

PROTECTING YOUR HOME

The following is a basic checklist of simple precautions you can take to help avoid burglary and/or theft.

1. Do not leave messages indicating your absence on your mailbox, door, or phone machine.
2. Use electric timers inside your home to turn on lights, T.V. or radios, during your absence.
3. Have a friend or neighbor pick up newspapers and flyers from your yard or door if you are gone for an extended period of time. Also, have a friend, neighbor, or family member pick up your mail or stop it at the post office.
4. Have your yard cared for during an absence.
5. Call your Police District to report and advise of vacation absences.
6. If you see a suspicious person or vehicle, get a good description of the person and/or vehicle.



Protecting Your Home While You're Away

Among the burglar's favorite targets are homes of people away on vacation. The burglar knows that he/she has plenty of time and does not have to pass up anything of value to him/her. You can avoid most of the risks by taking a few precautions and making some arrangements before you leave.

Discontinue newspaper and milk deliveries. Notify the post office to hold your mail, or arrange to have a neighbor or friend pick up the mail and newspapers. A mailbox stuffed with mail, a collection of daily newspapers or handbills at your door, and other signs of your absence are give-aways to the cruising burglar. Arrange for your lawn to be raked and trimmed, or the snow to be shoveled from your walk while you're away.

Don't publicize your departure. Avoid newspaper write-ups about your vacation plans. Don't have your telephone temporarily disconnected. If a burglar uses the phone to check on a possible target, it's better that he/she thinks you are simply temporarily out rather than to know you're away for a prolonged period of time. You should, however, turn the volume level of your telephone bells as low as possible before you leave. If a burglar outside your house hears a ringing phone that's not being answered, he/she may feel reassured you're not at home.

Leave a key to your house with a neighbor or friend and arrange for them to check the house regularly. Give your neighbor or friend an itinerary of your trip so you can be reached in an emergency.

If you're driving and can't be sure where you'll be staying, your neighbor can have the state highway patrol locate you if the officer has the license number of your car and knows the general route you plan to take.

Don't leave all of the drapes tightly closed while you're away. Leave a few of them open or partly open, and ask the neighbor to readjust them from day to day. Leave at least one light burning, perhaps in a bathroom or hall, all the time you're gone.

One or two lamps should be controlled by time clocks to turn on at dusk and off at your normal bedtime. Your neighbor can turn the outside lights on in the evening and off in the morning, or you can use photo cell outside lights.

You may feel you'll be imposing on your neighbor or friend too much by asking him/her to do all of this for you. You can be sure, though, that your neighbor won't mind if he/she knows you'll take the same interest in his/her house while he's/she's away. Neighbors who discuss their vacation plans with each other enjoy their vacation trips more.

Make a final safety check of the house before you leave to confirm that all doors and windows are securely locked; and, above all, don't leave a note taped to your door advising callers that you're away.

If you live alone periodically check in with a family member or friend.

How to Discourage Burglars

In taking steps to protect your home and its contents, bear in mind that no home can be protected like Fort Knox. All of the locks, bars, lights and bells you could install cannot guarantee total protection. You can only make your home burglary-resistant, not burglary-proof.

It's important to realize, though, that most residential burglars devote little if any time to advance planning of any specific break-in. Their crimes are, for the most part, crimes of opportunity. They pick what appears to be an easy mark. If their advance checking and closer examination reveal a greater risk than anticipated, they move on to a safer target. A burglar needs only one opening. Don't give it to him.

The residential burglar, including the novice or the juvenile, should not be underrated. The burglar knows he/she must gain entry fast, move quickly while inside, then get out. The burglar has learned many things to look for to assure easy entry, and he/she can spot a number of these signs while cruising down the street or cutting across a yard.

Once inside, the burglar knows all of the favorite hiding places for valuables, as well as some of the offbeat or unique places. The burglar often works with a partner for faster coverage of the house. Your unprotected home can be stripped of most of your valuables in three to five minutes from approach to departure, including such bulky items as stereo equipment and television sets.

The more you can do to keep your home from looking like an easy target, the safer you are. Start by making it as difficult as possible for the intruder to make a quick

and quiet entry. The more obstacles you can place in his path, the less the chance of a break-in. There are also many steps you can take to minimize your loss and improve your chances of recovery if a burglary does occur.

Your first step should be a complete security check of your home. Always maintain an occupied look by keeping the lawn trimmed, leaves raked, snow shoveled. Keep bushes and shrubs trimmed. Untrimmed shrubs, especially near the house, provide good hiding places and can often permit a burglar to take his/her time working on a door or window without risk of being observed. Lawn furniture left stacked against the house can give him the same advantage. Heavy shrubs and tall stockade fences can give you a lot of seclusion, but they won't keep intruders out. If your neighbors can see the back of your house, you'll enjoy less privacy but more safety.

Keep doors and entryways well lighted, including the driveway and garage areas. Burglars and attackers don't like lights. Replace burned-out bulbs immediately. Don't leave the lawn cart or a child's wagon outside either. It can simplify the burglar's job of getting your valuables to his/her car, which he/she may have parked a block away.

Whether you're at home or away, keep garage doors closed. To a burglar, open garage doors could mean no one is at home. It could also invite the burglar to use your ladder or tools to break into the house, to say nothing of what he might steal from the garage: tools, bicycles, sporting goods, car, or whatever he/she might strip from the car.

Securing Your Doors and Windows

Check the locks on all doors. You've heard that locks only keep honest people honest, but picking a good quality lock requires the skill of a professional. Most cheaper locks can be picked quite easily or opened with any one of a number of master keys.

Many doors with the lock in the knob can be opened with a credit card, a strip of plastic or a screwdriver; or the lock can be broken by twisting the knob with a quick turn of a pipe wrench. Many spring-loaded snap-locks that mount on the inside of the door can also be opened

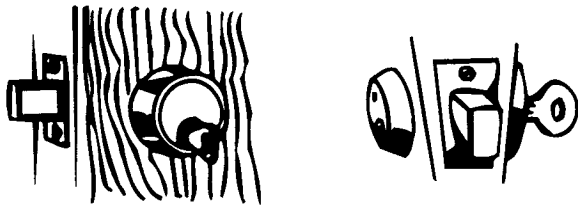

with a credit card. A dead-bolt requiring a key to lock or unlock is best.

Any glass-paneled door, other than sliding patio type, should have metal grillwork over the glass and a lock that can't be opened by breaking the glass and reaching inside. The safest lock for this type of door is a double cylinder dead-bolt requiring a key on both sides.

When you move into a house or apartment, have the lock tumblers changed by a locksmith to assure that

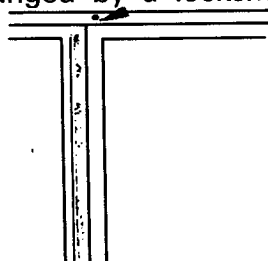

PINNED WINDOW

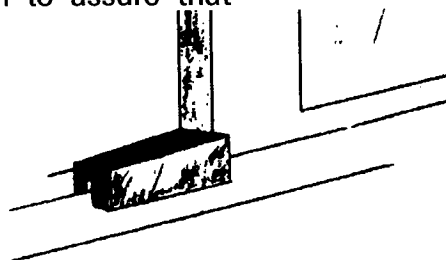

ANTI-SLIDE BLOCK

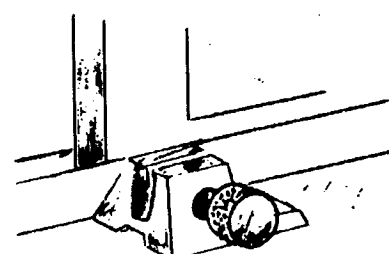

SLIDE BOLT

any prior resident still in possession of keys can't get in.

Don't have more keys made than necessary. Each family member should have one, but don't allow them to be passed out to delivery or maintenance people. You may find it advantageous to leave one with a neighbor, but don't hide one under the door mat or in the mailbox. Burglars know more of those key hiding places than you do.

Door hinges should also be protected. Remove two screws opposite each other on the hinge plates. Install a headless screw in the hinge plate mounted on the door frame. The screw should protrude at least 1" and enter the other hole when the door is closed.

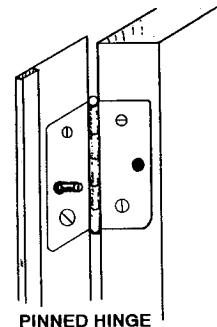

PINNED HINGE

Check all windows to be sure they are lockable. Securing sliding windows presents a particular problem in that the primary objective is to keep the window from sliding or being lifted up and out from the track. There are many manufactured products available for securing these types of windows. Shown on these pages are some suggestions.

THE STRIKE PLATE AREA IS THE WEAKEST POINT IN ANY DOOR

Standard flat strike plate on a wooden jamb can't hold up against a swift kick

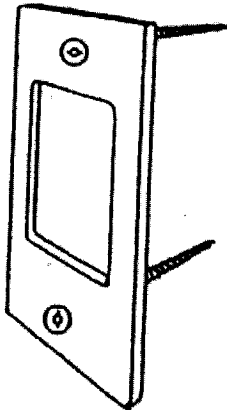

High Security Strike Plate

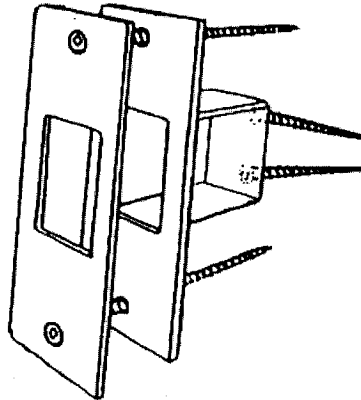

Filler Plates Used to Close Frame-Structure Gap

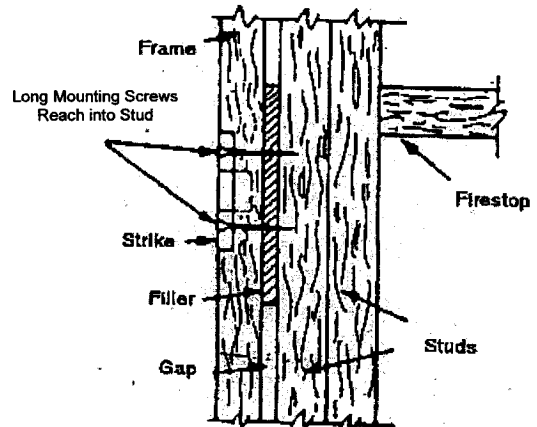

Remove the STRIKER PLATE. Drill the existing hole deeper into the frame. Drill the new hole as far as the first upright support, which is usually 4-6 inches into the frame. Insert a pipe just large enough to receive the dead bolt throw. Replace the striker plate.

NOTE: Use great caution when working near electric doorbell or light switch wires which may be in the wall.

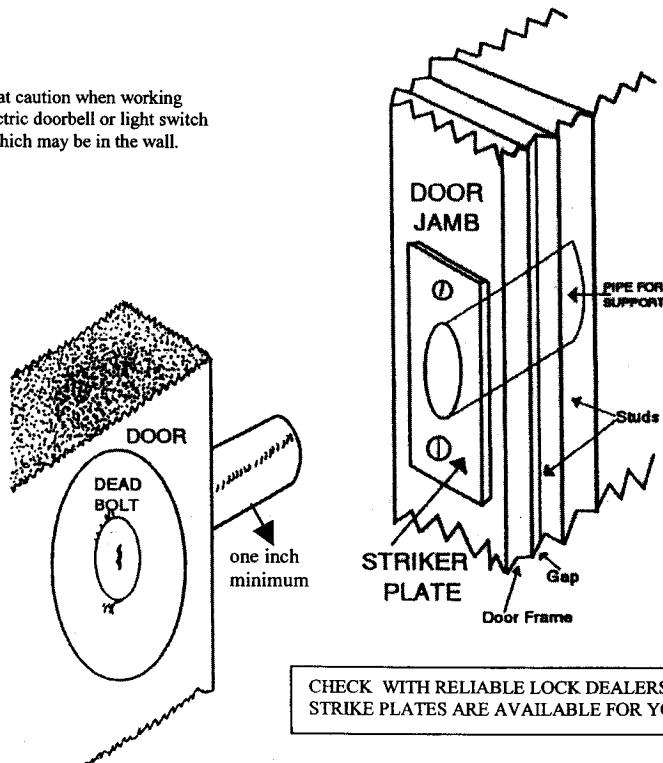

CHECK WITH RELIABLE LOCK DEALERS TO SEE IF LONGER STRIKER PLATES ARE AVAILABLE FOR YOUR LOCKS.



SASH LOCK

Although sliding windows can be blocked with strips of wood or broomsticks cut to the proper length and laid in the groove of the sill, a far better method is to install a lock on the window frame itself. This lock will adequately secure the permanent and sliding portions of the window by way of a lock unit operable only by a key. Sash windows should also be secured in the same manner.

Sliding glass "patio" doors should be secured in the same manner as sliding windows. A dowel stick or broomstick would secure the sliding glass doors, but a better method is a locking device to secure both portions (permanent and sliding) of the glass door together. Here are some examples of manufactured products available on the commercial market.

Basement windows, especially in many older homes, may be forced easily. They should be secured. If your basement windows are vulnerable, consider installing a lock on the door at the top of the basement stairs.

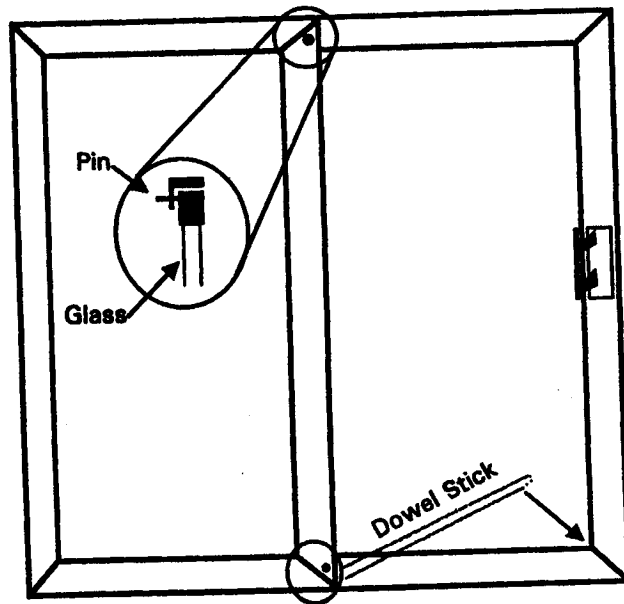

Exterior and Interior Lighting

Exterior lighting is important, particularly when the yard area is obscured by high nonremovable shrubbery. The best possible location for outside lights is under the eaves. This makes ground-level assault more difficult. You can buy an inexpensive photo-electric cell timer which will automatically turn the lights on at dusk and turn them off at dawn.

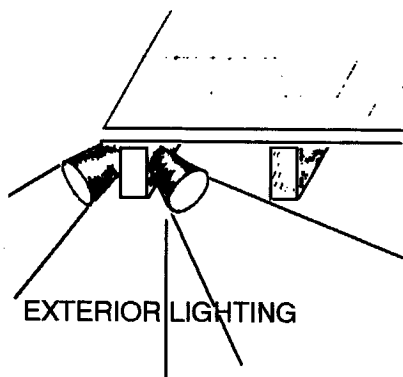

Interior lighting is equally as important. The best source of lighting is a living room light, whether you are home or not. Again, use a timer or photo-electric cell to automatically turn the light on at dusk. The illumination coming from this source is sufficient to silhouette an intruder through many windows in your home. It is also confusing to the burglar as to whether you are away, at home, or asleep on the sofa. Another method meant to confuse a burglar is the use of an additional timer connected to a radio or television. Used alternately, timers are very valuable devices to deter the would-be burglar.

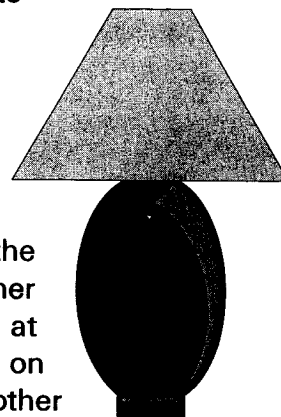

For your personal safety while at home, install a wide angle viewer in your door to allow you to "know your visitor" and thus avoid allowing access to your home by an unwanted intruder.

If you have any questions about home security or would like a home security check, contact your local District Station.

WHAT YOU SHOULD KNOW ABOUT BURGLAR ALARM SYSTEMS

Know Your Local Laws

The following information is quoted from the Revised Municipal Code of the City and County of Denver. The "legalese" may be a little hard to understand, but if you are thinking about an alarm system, and you live in the City and County of Denver, you should know what your responsibilities will be.

42-102 Definitions

Alarm system: A device or an assembly of equipment which is intended to alert persons outside a premises to a forcible entry or intrusion into the premises or to a fire or conditions similar to fire on the premises; whether by means of an audible response, by automatically dialing an emergency agency, by connection to a private answering point for the purpose of reporting to emergency agencies, or by direct connection to an emergency agency.

Avoidable alarm: The activation of an alarm system through mechanical failure, malfunction, improper installation, or the negligence of the owner, user, custodian or lessee of an alarm system, or of his employees or agents, or through any other cause which through direct connection to an emergency agency, or which through notification of emergency agency by a private answering point or automatic dialing device, or which through notification to an emergency agency by any other second party or means indicates that an emergency situation exists requiring response by an emergency agency within the city when, in fact, no such emergency situation exists. An avoidable alarm also includes the knowing or intentional activation of an alarm to an emergency agency when the activator knows that an emergency situation does not exist. Avoidable alarm does not include alarms activated by violent conditions of nature, such as blizzards, tornadoes, earthquakes, or any other similar cause beyond the control of the user of an alarm system. Activation of an alarm system under circumstances in which the activator reasonably believes that an emergency situation exists is not an avoidable alarm.

Local alarm system: A signaling system which, when activated, causes an audible signaling device to be activated outside the premises within which the system is installed.

Private answering point: A business which offers the service of receiving emergency signals, monitoring such signals, and relaying them to an emergency agency.

Proprietary system: An alarm, sound and/or recording alarm and supervisory signals at a control center located within the premises protected by the alarm, which does not activate an audible signaling device to alert persons outside of the premises on which the alarm system is located and not intended to alert an emergency agency, the control center being under the supervision of the proprietor of the protected premises. If a proprietary system includes a signal line connected directly or by means of an automatic dialing device to an emergency agency or to a private answering point, or to a local alarm system, it thereby becomes an "alarm system" as defined in this section.



Choose a Reputable Company

Make sure you deal with an established firm with a proven history of service and performance. All of the employees of the alarm company who sell or service alarm equipment, and thus have access to your home, should be bonded. The company should be willing to supply a list of nearby home-owners or commercial installations who are satisfied customers and who may be contacted for references. After you've selected the company (or companies), call and make an appointment with a representative to meet with you. Be sure to get the name of the person who will be calling on you.

It is always advisable to obtain two or three bids from different companies to ensure a competitive bid and greater exposure to the variety of alarm systems available.

Decide on a System

There are a number of systems available, but you should know that there is no such thing as a burglar alarm system that will make your home burglar-proof 100% of the time. However, a good alarm system can deter or detect most intruders, and will afford an added measure of security when you are away from your home. Some alarm systems are strictly for perimeter protection and others for interior protection. The best system is usually one that protects the perimeter of your home combined with some interior protection. The interior type detects an intruder after he has entered the home or by-passed the perimeter system. Preference for the desired level of security and type of system used depends entirely upon your budget, the design of your home and the amount of property you are protecting. The cost of an alarm system varies greatly between a local and central station type. Such factors as the distance to the alarm company, local telephone rates, the amount of wiring required and the construction materials in your home have a direct bearing on the cost and installation of an adequate system.

Things to Watch for:

Here are some ways to check the quality of a system.

- The complete system should operate on house current and/or back-up battery supplied current. (Self-contained, trickle-cell, battery-powered units are satisfactory if equipped with a reliable testing device.)
- The system should have some monitoring device to alert the homeowner if any malfunction exists prior to operation.
- The audible alarm feature of the system should be heard in any part of the protected premises, and loud enough to alert neighbors and/or passer-bys.

Choose a Reputable Company

Make sure you deal with an established firm with a proven history of service and performance. All of the employees of the alarm company who sell or service alarm equipment, and thus have access to your home, should be bonded. The company should be willing to supply a list of nearby home-owners or commercial installations who are satisfied customers and who may be contacted for references. After you've selected the company (or companies), call and make an appointment with a representative to meet with you. Be sure to get the name of the person who will be calling on you.

It is always advisable to obtain two or three bids from different companies to ensure a competitive bid and greater exposure to the variety of alarm systems available.

Decide on a System

There are a number of systems available, but you should know that there is no such thing as a burglar alarm system that will make your home burglar-proof 100% of the time. However, a good alarm system can deter or detect most intruders, and will afford an added measure of security when you are away from your home. Some alarm systems are strictly for perimeter protection and others for interior protection. The best system is usually one that protects the perimeter of your home combined with some interior protection. The interior type detects an intruder after he has entered the home or by-passed the perimeter system. Preference for the desired level of security and type of system used depends entirely upon your budget, the design of your home and the amount of property you are protecting. The cost of an alarm system varies greatly between a local and central station type. Such factors as the distance to the alarm company, local telephone rates, the amount of wiring required and the construction materials in your home have a direct bearing on the cost and installation of an adequate system.

Things to Watch for:

Here are some ways to check the quality of a system.

- The complete system should operate on house current and/or back-up battery supplied current. (Self-contained, trickle-cell, battery-powered units are satisfactory if equipped with a reliable testing device.)
- The system should have some monitoring device to alert the homeowner if any malfunction exists prior to operation.
- The audible alarm feature of the system should be heard in any part of the protected premises, and loud enough to alert neighbors and/or passer-bys.
- Be aware that animals, hanging objects, curtains on open windows, balloons, etc. can activate motion sensors.

- Temporary losses of power, such as blackouts, which cause the system to change over to battery power, should not trigger an audible alarm.
- Any external components of the system should be made as inaccessible as possible so that intruders find it difficult to cut through wires or cables outside the home in an attempt to deactivate the system.
- Main components of the system should meet the electrical safety standard set by Underwriters' Laboratories, Inc.
- Internal wiring should be installed in conformity with the standards of the Electrical Code.
- If you have a fire alarm installed with your burglar alarm system, it should include a test facility for checking to see if it is functioning correctly.
- Make sure warning decals are displayed advertising your home is protected by an alarm system.
- Reset feature - every alarm system using an audible annunciator should have a reset feature to turn the bell and/or siren off after sounding for a maximum of five (5) minutes.

USE AND APPLICATION IN HOMES AND BUSINESSES

Local Alarm Systems

A signaling system, which when activated causes an audible signaling device to be activated outside the premises within which the system is installed.

Perimeter Alarm Systems

The basic home system is a simple closed circuit loop system consisting of contacts or screens on doors and windows. Most are designed to ring a bell or activate a siren and/or illuminate the area to scare off an intruder. This will usually scare away residential burglars. This type of system, in case of a power failure, should always have a battery backup, just in case the thief should shut off the power.

There are several types of sensors used on perimeter alarm systems.

Magnetic Contacts: One of the most widely-used residential devices is an electro-mechanical contact consisting of a magnet in one sealed enclosure and a switch in another sealed enclosure. They attach to doors, windows, transoms and other openings and are wired to a central control box.

Read Your Contract

The alarm company should make a written proposal and give you a copy of the contract you will be signing. Make sure you read it thoroughly. Sometimes the contract obligates the customer for a number of years. All costs, including fines assessed to the alarm company for dispatching to an address without a valid alarm user permit, may be passed on to the customer. Never sign a contract which does not list all the points of protection or itemize the equipment installed. No reliable firm will offer a "lifetime" guarantee.

If your salesman says your system will reduce your insurance premiums, don't take his word for it. Check with your agent. Also, make sure their maintenance contract is in order and the agreement stays with the home, even though it may be sold.

Remember that your property and perhaps your personal safety are at stake. What appears to be a "bargain" may actually prove to be an easily compromised, or extremely limited alarm system.

In this regard, be sure that the sensor devices (magnetic contacts, motion detectors, pressure mats, screen, etc.) to be installed are Underwriters' Laboratory, Inc. approved for burglary protection. Your alarm company representative can show you the listing of the equipment in a UL publication.

You and Your Alarm System

The effectiveness of your system depends on you. Understand how it works, and what it takes to keep it operating properly. Ask the company to give you written instructions for the operation and testing of your system. By law, the companies are required to provide these instructions. Be sure to let your neighbors know you have an alarm system and ask them to call the police if the alarm is activated.

When the alarm is installed, try to have all members of your family present for instructions.

Read Your Contract

The alarm company should make a written proposal and give you a copy of the contract you will be signing. Make sure you read it thoroughly. Sometimes the contract obligates the customer for a number of years. All costs, including fines assessed to the alarm company for dispatching to an address without a valid alarm user permit, may be passed on to the customer. Never sign a contract which does not list all the points of protection or itemize the equipment installed. No reliable firm will offer a "lifetime" guarantee.

If your salesman says your system will reduce your insurance premiums, don't take his word for it. Check with your agent. Also, make sure their maintenance contract is in order and the agreement stays with the home, even though it may be sold.

Remember that your property and perhaps your personal safety are at stake. What appears to be a "bargain" may actually prove to be an easily compromised, or extremely limited alarm system.

In this regard, be sure that the sensor devices (magnetic contacts, motion detectors, pressure mats, screen, etc.) to be installed are Underwriters' Laboratory, Inc. approved for burglary protection. Your alarm company representative can show you the listing of the equipment in a UL publication.

You and Your Alarm System

The effectiveness of your system depends on you. Understand how it works, and what it takes to keep it operating properly. Ask the company to give you written instructions for the operation and testing of your system. By law, the companies are required to provide these instructions. Be sure to let your neighbors know you have an alarm system and ask them to call the police if the alarm is activated.

When the alarm is installed, try to have all members of your family present for instructions.

- NOTES -



